



medi

medi's comfort supports

User comfort for the whole day.



medi. I feel better.





medi World of Compression

A strong brand. A wide range of products. Holistic concepts.

The medi World of Compression: A signpost to the future with over 70 years' experience in compression. Your partner for the highest requirements of quality, innovation and design. Let us shape the future together and create positive brand experiences – for you and your patients.

Offers security, stability and noticeable relief

Beneficial and effective therapy with products that combine proven medical effectiveness with special user comfort.

The wide range of supports from medi allows you to offer your patients the fitting solution for many indications. Supports from medi are tailored to the needs of your patients, down to the smallest detail. New technologies and numerous comfort features ensure that patients enjoy wearing the support on a regular basis – a big plus for achieving therapy adherence and long-term satisfied users.

medi's comfort knit

medi Comfort Zone

Soft zones in the sensitive flexor areas ensure that the support does not press on or cut into the skin, even when worn all day long

Fibre technology

Functional and natural fibres

The comfortable fabric combines breathable, functional fibres with a new natural fibre made of eucalyptus. The specific fibre combination supports the diffusion of moisture and helps to protect the moisture balance of the skin. Thanks to the smooth structure of the natural fibres, the comfort supports are particularly soft against the skin

medi compression technology

The compressive knitted fabric can improve proprioception. The improvement in proprioception supports the body's own guidance and stabilizes the joint

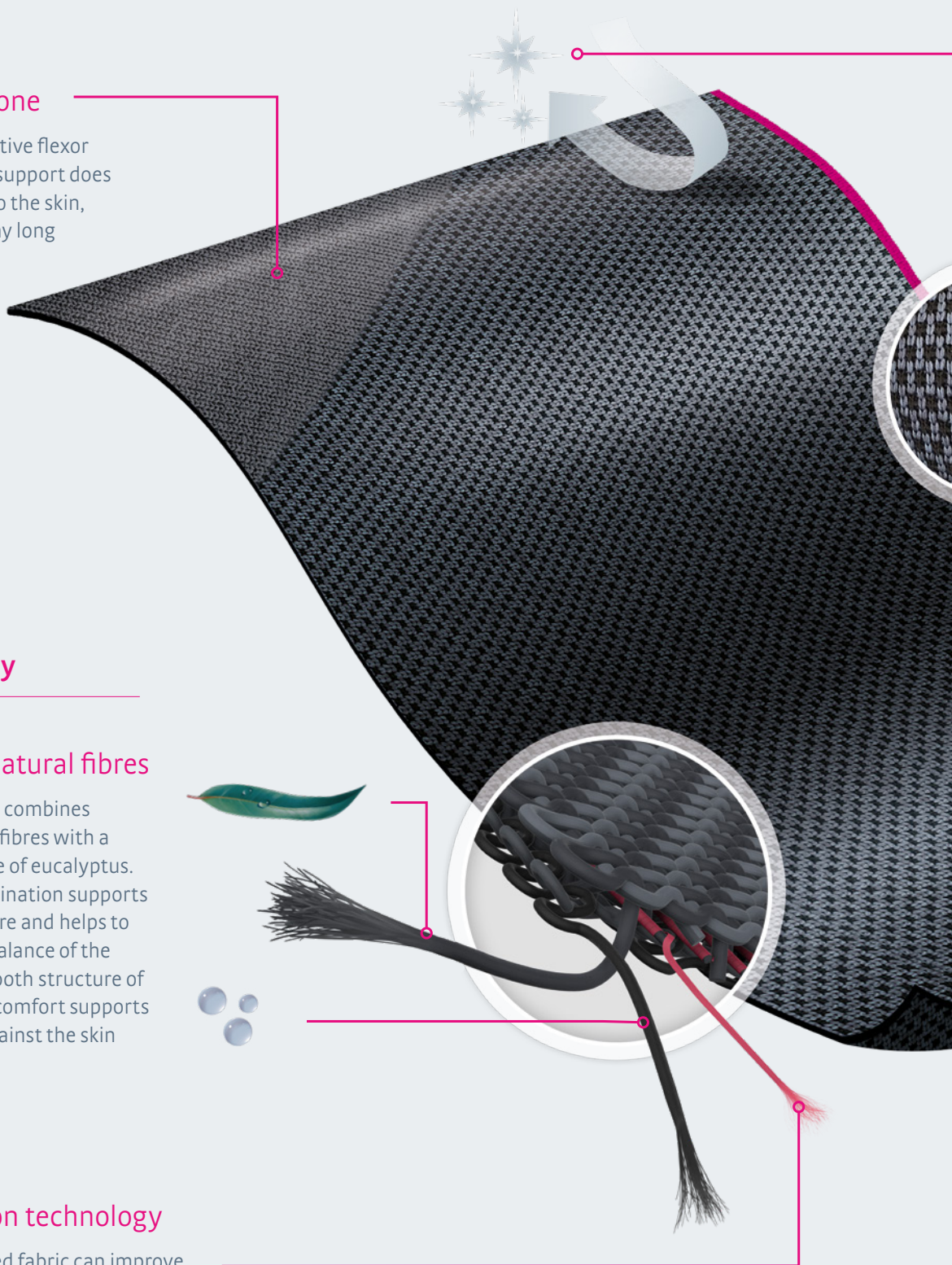

medi Clima Fresh

Integrated Clima Fresh function
– odour-inhibiting effect

Fit and elasticity

Highly elastic across and along the length with total compression effect – for a secure fit and reliable stability for all body types

Very easy to use

When it comes to bandages, the wellbeing factors are wearing comfort as well as easy handling. This is crucial to ensure that the aid is worn regularly. For 81 per cent of patients, it is important that the product is easy to put on and take off.¹

The medi comfort knit features new materials and an improved knitted fabric binding. This has significantly improved the longitudinal as well as transverse elasticity of the comfort bandages while maintaining the same compressive effect and stability. The benefit for users: It takes less force to put on the bandage. The cleverly attached hand loops also facilitate closing the comfort back bandages.

medi Clima Comfort*

- wicks moisture away from the skin's surface quickly
- guarantees a high level of breathability

¹ Allensbach Institute for Public Opinion Research on behalf of eurocom e.V. (March 2014), Elastic bandages and orthoses: Quality of care and product satisfaction – results of a representative patient survey.
² Gardon-Mollard C., Gogué-Meunier G. Etude comparative du transfert de la vapeur d'eau dans différents articles de compression médicale. Phlébologie 2011,64(2):53-60.
* Scientifically tested by French institute IFTH2. The test results show that Clima Comfort technology from medi assures climate control between the skin and the stocking. With 11/12 points, medi achieved an outstanding overall score



Genumedi® plus

Knee support with patella silicone ring and additional straps

medi Comfort Zone
with rippled structure for a higher level of comfort in the hollow of the knee

Open inner border of the patella ring
Perceptibly decreases pressure on the kneecap due to the open enclosure of the patellar silicone ring



Non-slip
Optimal anti-slip feature: silicone dot coating and secure connection between the knit fabric and lateral incorporated rod

Additional straps
Ensure a high level of comfort

Knee-pad with 3D profile
Dissipates swelling (oedema, haematoma) via integrated 3D-silicone pad

Intended purpose: Genumedi® plus is a knee support for soft tissue compression.



Genumedi®

Comfort knee support for soft tissue compression with 3D silicon pad

Non-slip ③
Optimal anti-slip feature: silicone dot coating and secure connection between the knitted fabric and lateral splint material

medi Comfort Zone ①
With rippled structure for a higher level of comfort in the hollow of the knee

Open inner border of the patella ring ②
Perceptibly decreases pressure on the kneecap due to the open enclosure of the patellar silicone ring



Extrawide Version



1. With topband



2. With innovative cuff

medi Soft Edge
No cutting-in of the ends of the bandage thanks to the unique knitting technique



3D silicone pad
Dissipates swelling (oedema, haematoma) via integrated 3D-silicone pad

Also available as Genumedi® E+motion®

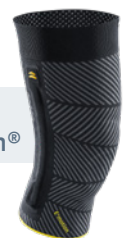

Intended purpose: Genumedi® is a knee support for soft tissue compression.

¹ Comparative test by the Institute for Medical Physics, University of Erlangen / Nuremberg (2009; unpublished).



Genumedi® PA

Knee brace for relieving pain at the Pes anserinus tendon insertion



Grip-Ons
Lateral grip knobs additionally facilitate donning

medi Comfort Zone with rippled structure
Higher level of comfort in the hollow of the knee

3D-thigh pads
Restoration of muscular balance in the long term

3D-patella pad
Laterally reinforced for a secure guiding of the patella

3D-tendon pad
Stimulation of the Pes anserinus tendon insertion for pain relief

Offset belt system
Well-balanced distribution of pressure

Therapy support

Free in every pack:
Information for appropriate exercises

Access physio exercises using the QR code or short URL medi.biz/PA



Also available as Genumedi® PA extrawide with topband



Intended purpose: Genumedi® PA is a brace which guides patella tracking.



Genumedi® PT

Knee brace promoting muscular balance in cases of patellar lateralisation

Strap system

Individual pressure adjustment on Pes anserinus tendon insertion

3D-tendon pad

Stimulation of the Pes anserinus tendon insertion for pain relief



Grip-Ons

Lateral grip knobs additionally facilitate donning



3D-thigh pads

Restoration of muscular balance in the long term



3D-patella pad

Laterally reinforced for a secure guiding of the patella



medi Comfort Zone with rippled structure

Higher level of comfort in the hollow of the knee



Therapy support

Free in every pack:
Information for appropriate exercises

Access physio exercises using the QR code or short URL **medi.biz/PT**



Also available as Genumedi® PT extrawide with topband



Intended purpose: Genumedi® PT is a brace which guides patella tracking.



Genumedi® PSS

Knee brace for relieving pain at the patellar tendon insertion



Grip-Ons
Lateral grip knobs additionally facilitate donning



Patella-Strap
• individual pressure adjustment on the patellar tendon
• no cutting-in thanks to offset strap system

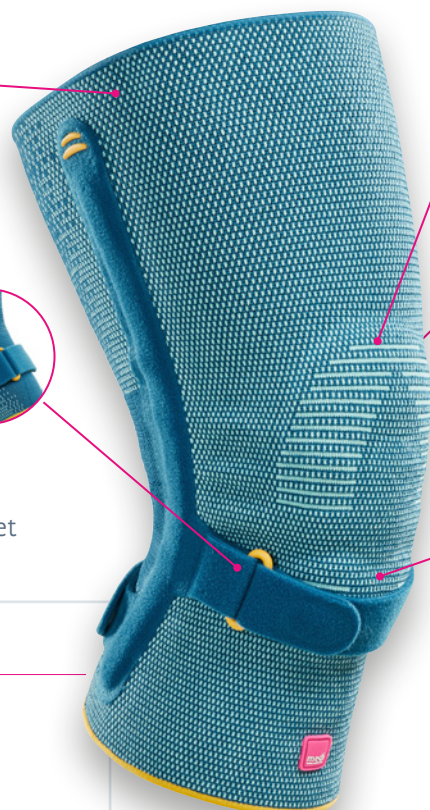

3D-patellar pad
Secure guiding of the patella



medi Comfort Zone with rippled structure
Higher level of comfort in the hollow of the knee



3D-tendon pad
Stimulation of the patellar tendon for pain relief

Therapy support

Free in every pack:
Information for appropriate exercises

Access physio exercises using the QR code or short URL **medi.biz/PSS**



Also available as **Genumedi® PSS extrawide with topband**



Intended purpose: Genumedi® PSS is a brace for influencing the patella glide path.



Genumedi® pro

Knee brace for physiological guidance of the knee joint

Grip-Ons

Lateral grip knobs additionally facilitate donning



Individually adjustable straps

On upper and lower leg for additional hold



Therapy support

Free in every pack:
Information for appropriate exercises

Access physio exercises using the QR code or short URL medi.biz/pro



Easy-glide hinges

For relief on the knee joint and support of the physiological roll/glide movement



3D silicone pad

Pain relief and dissipation of swelling (oedema, haematoma) via integrated 3D silicone pad

Open enclosure of the patella for perceptible pressure relief on the kneecap

medi Comfort Zone with rippled structure

Higher level of comfort in the hollow of the knee



Also available as Genumedi® pro extrawide with topband



Intended purpose: Genumedi® pro is a knee support brace without limitation of extension / flexion.





①



②

Lumbamed[®] sacro

Modular pelvic support for stabilisation with massage pads

Modular design

Allows customised adjustment to the onset of pain and degree of activity by day and night



Flexibly positionable massage pads

Targeted massaging of the painful areas and acceleration of the healing process thanks to flexibly positionable pads



Tension straps ②

For infinitely variable and individually adjustable pressure

Bilateral hand loops ①

The support is particularly simple to apply

Accessories

Fastener for elastic comfort knit



Supplementary digital therapy support access physio exercises
Using the QR-Code or Short-URL
medi.biz/sacro



intended purpose: Lumbamed[®] sacro is a brace for stabilisation of the pelvis.



Lumbamed® maternity

Lumbar support for stabilisation during pregnancy



Stomach belt
Can be adjusted without interval and is easy to adjust to accommodate the growing stomach

Tension straps
To adjust the device to the individual ①

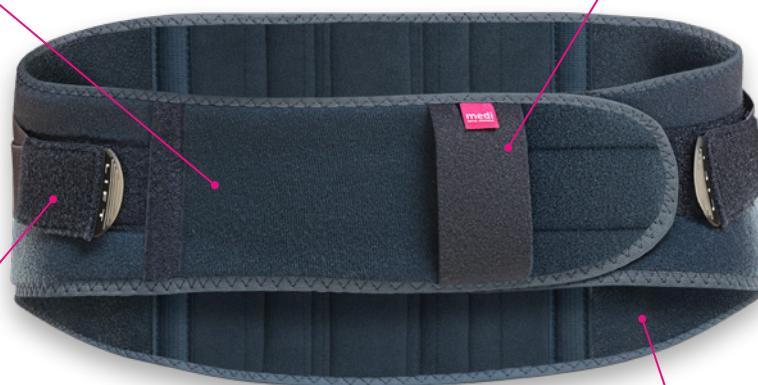

External hand loop
Enable the brace to be put on easily: little energy is required ②

Material wraps around the body
Pleasant, soft material, along with a shape that moulds to the body

Therapy support
Using the QR-Code or the Short-URL medi.biz/maternity to access patient information



Intended purpose: Lumbamed® maternity is a brace for stabilising the lumbar spine using pressure that can be applied at different levels.



Lumbamed® plus

Lumbar support with massage pad

Integrated Vario-Flex pad ①

- with thinner, breathable pad cover
- improved climate management
- optimized ventilation holes for pleasant wearing comfort

Bilateral hand loops ②

The support is particularly simple to apply

Folding edges of the fastener

To ensure a high level of comfort during movement and while seated

Soft inner surface of the fastener

Thanks to a special hybrid fabric created from high-tech fibre and natural eucalyptus fibre

Opening tab ③

Quick to open with Folding edges just one finger

Comfort Zone

Anatomical cut-out in sensitive bending area for a high level of comfort

Therapy support

Using the QR-Code or the Short-URL medi.biz/Lumbamed to access physiotherapy exercises



Intended purpose: Lumbamed® plus is a brace for stabilisation of the lumbar spine with back pad.



Lumbamed® basic

Lumbar support for stabilisation

Stabilising rods ①

Stabilisation of the lumbar spine and lumbosacral junction via four dorsally integrated back rods

Bilateral hand loops ②

The support is particularly simple to apply



Folding edges of the fastener

To ensure a high level of comfort during movement and while seated



Opening tab

Quick to open with just one finger

Soft inner surface of the fastener

Thanks to a special hybrid fabric created from high-tech fibre and natural eucalyptus fibre



Comfort Zone

Anatomical cut-out in sensitive bending area for a high level of comfort

Therapy support

using the QR-Code or the Short-URL medi.biz/Lumbamed to access physiotherapy exercises



Intended purpose: Lumbamed® basic is a brace for stabilisation of the lumbar spine.



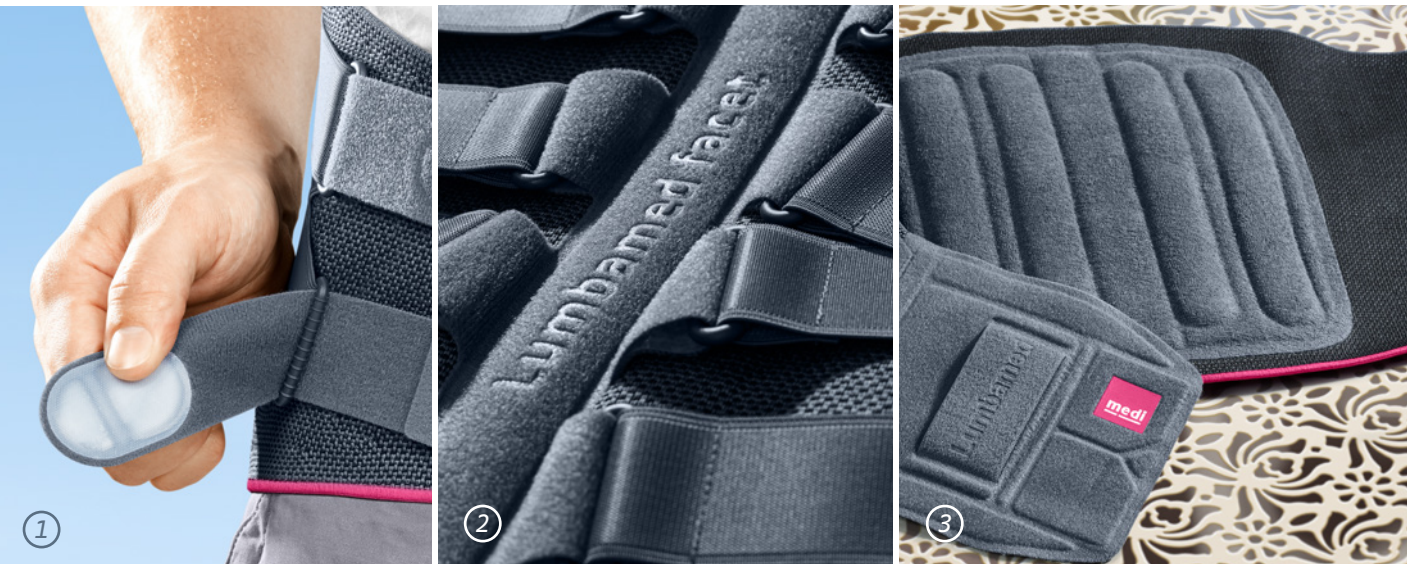

Lumbamed® facet

Lumbar support for targeted relief of the facet joints

Stabilising rods ③
Targeted relief of the facet joints through effective reduction of lordosis

Bilateral hand loops
The support is particularly simple to apply

Extra-flat buckle end ②

Folding edges of the fastener
To ensure a high level of comfort during movement and while seated

Soft inner surface of the fastener
Thanks to a special hybrid fabric created from high-tech fibre and natural eucalyptus fibre

Comfort Zone
Anatomical cut-out in sensitive bending area for a high level of comfort

Double 3-point strap system ①

1. Precise dosing of the intra-abdominal pressure
2. Straightens the pelvis
3. Flattens the spinal lordosis and stabilises the lumbar spine and the lumbosacral junction

Intended purpose: Lumbamed® facet is a brace for partial stress relief of the lumbar spine via correction of lordosis.



Lumbamed® disc

Lumbar support with adjustable stabilisation system

Interchangeable stabilising rods ③

Lordosis in the lumbar spine is corrected via compression of the abdomen and integrated support elements

Tension straps

For smooth and individually regulated pressure



Folding edges of the fastener

To ensure a high level of comfort during movement and while seated

Soft inner surface of the fastener

Thanks to a special hybrid fabric created from high-tech fibre and natural eucalyptus fibre



Comfort Zone

Anatomical cut-out in sensitive bending area for a high level of comfort

Bilateral hand loops

The support is particularly simple to apply

Modular flexibility for incremental mobilisation

- **Phase I:** stabilises and reduces strain on the lumbar spine with the optimised strap support system (= bridging pad with tension straps, four stabilising elements) ①
- **Phase II:** removable bridging pad including tension straps ②
- **Phase III:** interchangeable softer stabilising elements available as an option ③

Intended purpose: Lumbamed® disc is a brace for partial stress relief via correction of lordosis and functional mobilisation of the lumbar spine.



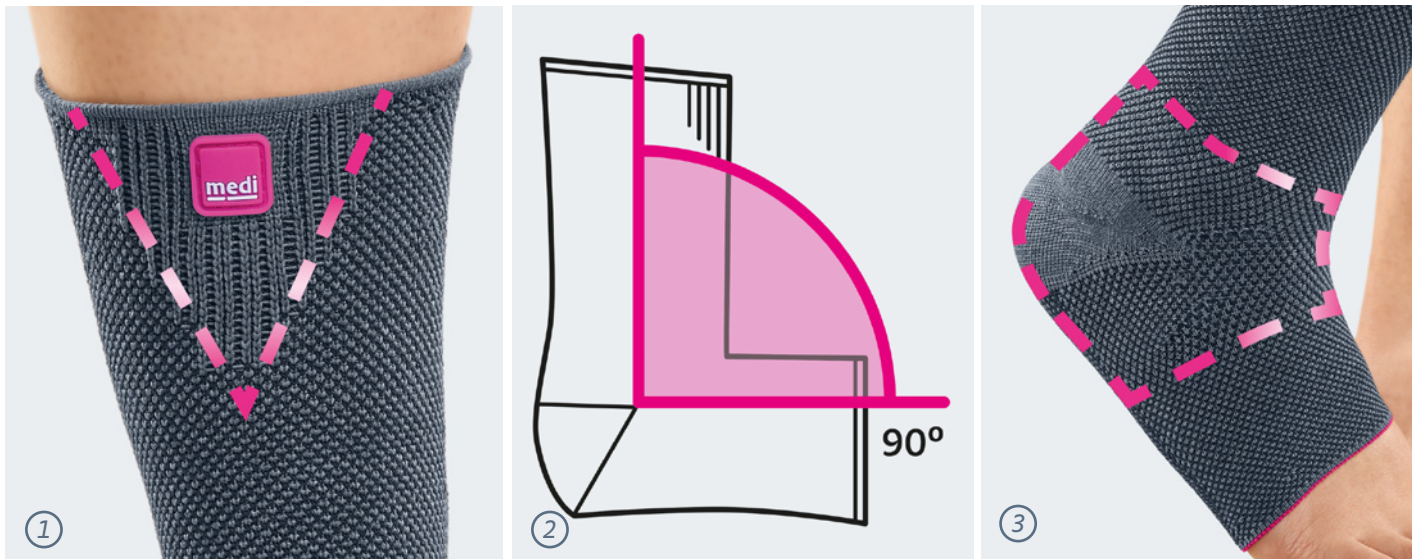

Achimed®

NEW

Comfort bandage for soft tissue compression of the achilles tendon with 3D silicone pad



3D silicone pad

Enlarged 3D silicone pad – split in two for a gentle massage effect without pressure on the Achilles tendon

Innovative knitted shape:

at a 90-degree angle, emphasises the arch of the foot, reinforces and lengthens the underfoot – for a good and comfortable fit ②



Comfort knit

Unique comfort knit with stretch zone on the top border for easier donning ①

Extended relief zone

in the instep area due to higher transverse and longitudinal elongation of the knitted fabric ③

Equipment

In every product pack



Easy to put on using included donning aid



Separate heel wedges for tendon relief

Supplementary digital therapy support
Access physio exercises using the QR code or short URL medi.biz/Achimed



intended purpose: Achimed® is a bandage for compression of the achilles tendon.



①

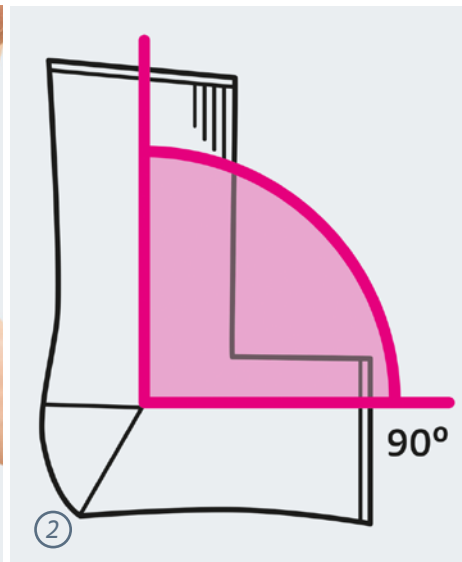

②

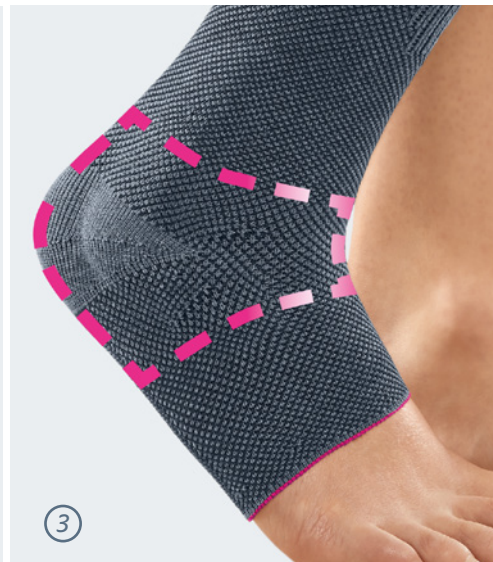

③

Levamed®

NEW

Comfort ankle support for soft tissue compression with 3D silicon pads



3D silicone pad for massage and swelling reduction



Innovative knitted shape: at a 90-degree angle, emphasises the arch of the foot, reinforces and lengthens the underfoot – for a good and comfortable fit ②

Unique comfort knit with stretch zone on the top border for easier donning ①

Extended relief zone in the instep area due to higher transverse and longitudinal elongation of the knitted fabric ③

Accessories

Easy to put on using included donning aid



Also available as Levamed® E+motion®



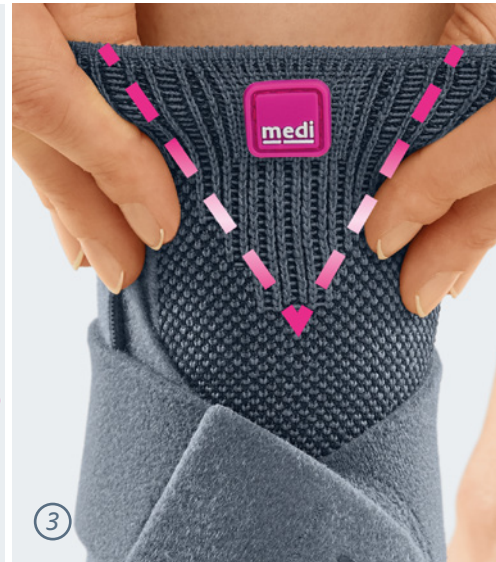

Levamed® active

NEW

Comfort ankle support for soft tissue compression with elastic strap

Proven stabilisation strap:

Can be individually shortened and removed



3D silicone pad

for a gentle massage effect and to reduce swelling



Unique comfort knit

with stretch zone on the top border for easier donning^③

Extended relief zone

in the instep area due to higher transverse and longitudinal elongation of the knitted fabric^①

Innovative knitted shape:

at a 90-degree angle, emphasises the arch of the foot, reinforces and lengthens the underfoot – for a good and comfortable fit^②

Accessories

Easy to put on using included donning aid



In every product pack

Intended purpose: Levamed® active is a support for compression of the soft tissue in the ankle joint with additional functional elements.





Manumed active

Comfort wrist support for soft tissue compression with stabilizing rod



Accessories

In every product pack

Donning aid
For easy donning

Also available as Manumed active E+motion®

Intended purpose: Manumed active is a wrist compression support.



Epicomed®

Comfort elbow support for soft tissue compression with 3D silicone pads

Wide cuff

Broad, flexible border for a secure and pleasant fit. Extra length in the upper arm to cover soft connective tissue ①

medi Comfort Zone ③

Soft, fine and elastic for noticeably greater user comfort, even in sensitive joint areas



3D silicone pad



Removable strap for individual pressure regulation

Innovative comfort knit fabric with a fit that moulds to the body and supple borders ②

Supplementary digital therapy support

Access physio exercises using the QR code or short URL medi.biz/epi



Also available as Epicomed® E+motion®



Intended purpose: Epicomed® is an elbow compression support with pads.

Product-overview

Genumedi® knee supports

Genumedi® plus

Knee support with patella silicone ring and additional straps

Standard: K.110.22*

* = size; colour=  silver



Genumedi®

Comfort knee support for soft tissue compression with 3D silicon pad

Standard: K.102.Δ0*

Extra-wide with innovative cuff: K.103.Δ1*

Extra-wide with tried and tested silicone top band: K.103.Δ7*

customisation possible

Δ = colour: 2 =  silver, 8 =  sand

* = size



Genumedi® PA

Knee brace for relieving pain at the Pes anserinus tendon insertion

Standard:

left: K.172.20*

right: K.173.20*

Extra-wide with tried and tested silicone top band:

left: K.172.27*

right: K.173.27*

* = size; colour=  silver



Genumedi® PT

Knee brace promoting muscular balance in cases of patellar lateralisation

Standard: left: K.142.24*
right: K.143.24*

Extra-wide with tried and tested silicone top band: left: K.142.28*
right: K.143.28*

* = size; colour:  silver

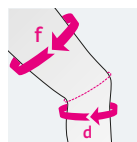

Measuring the thigh circumference (f) 15 cm above the middle of the knee, medial (on the inside).
Calf circumference (d) 5 cm below the middle of the knee, medial (on the inside).

Genumedi® knee supports

(f) cm	(d) cm	size
34 – 37	22 – 25	*0 ¹
37 – 40	25 – 28	*1
40 – 43	28 – 31	*2
43 – 46	31 – 34	*3
46 – 49	34 – 37	*4
49 – 52	37 – 40	*5
52 – 55	40 – 43	*6
55 – 58	43 – 46	*7
58 – 61	46 – 49	*8 ²
61 – 64	49 – 52	*9 ³

Genumedi® extra-wide knee supports

46 – 49	31 – 34	*3
49 – 52	34 – 37	*4
52 – 55	37 – 40	*5
55 – 58	40 – 43	*6
58 – 61	43 – 46	*7
61 – 64	46 – 49	*8 ²
64 – 67	49 – 52	*9 ³

¹ size 0 only available for Genumedi® PSS.

² size 8 only available for Genumedi® silver.

³ size 9 only available for Genumedi® silver with topband.

Extra-wide variants for Genumedi®

1. With proven topband

- Proven extra-wide function: secure fit, even with larger thighs and sensitive connective tissue
- Topband for even more support
- Topband makes the bandage longer
- This longer variant encloses the thigh area even better.



2. With innovative cuff

- New knitted binding at the top of the cuff (does not curl over)
- Proven extra-wide function: secure fit, even with larger thighs and sensitive connective tissue
- Modern appearance (same length as the standard Genumedi variant)
- Improved wearing comfort (comfortable knitted fabric instead of the topband)



This variant is particularly suitable for athletes or smaller people with larger thighs.

Product-overview

Genumedi® knee supports

Genumedi® PSS

Knee brace for relieving pain at the patellar tendon insertion

Standard:	K.150.30*
Extra-wide with tried and tested silicone top band:	K.150.37*

* = size; colour:  lyons blue

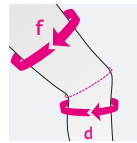

Measuring the thigh circumference (f) 15 cm above the middle of the knee, medial (on the inside).
Calf circumference (d) 5 cm below the middle of the knee, medial (on the inside).

Genumedi® pro

Knee brace for physiological guidance of the knee joint

Standard:	K.121.21*
Extra-wide with tried and tested silicone top band:	K.121.28*

* = size; colour=  silver



Product-overview

Lumbamed® Pelvic and back braces

Lumbamed® sacro

Modular pelvic support for stabilisation with massage pads

Unisex:	K.280.20*
---------	-----------

* = size; colour:  silver



Pelvic brace

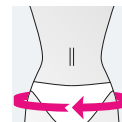

circumference hip (cm)	size
70 – 85 cm	*1
85 – 100 cm	*2
100 – 115 cm	*3
115 – 130 cm	*4
130 – 145 cm	*5

Lumbamed® maternity

Lumbar support for stabilisation during pregnancy

Standard: K.250.20*

* = size; colour:  silver



Back braces

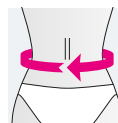

circumference waist (cm)	size
90 – 105 cm	*1
105 – 120 cm	*2
120 – 135 cm	*3

Lumbamed® plus

Lumbar support with massage pad

men: K.210.23*
women: K.210.Δ24*

Δ = colour: 2 =  silver, 8 =  sand; * = size

Colour sand only available for women

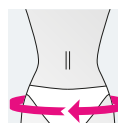

circumference hip (women) waisted model	size
76 – 86 cm	*1
86 – 98 cm	*2
98 – 111 cm	*3
111 – 125 cm	*4
125 – 140 cm	*5
140 – 155 cm ¹	*6

Lumbamed® basic

Lumbar support for stabilisation

men: K.200.23*
women: K.200.Δ24*

Δ = colour: 2 =  silver, 8 =  sand; * = size

Colour sand only available for women

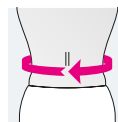

circumference waist (men) straight model	size
66 – 76 cm	*1
76 – 88 cm	*2
88 – 101 cm	*3
101 – 115 cm	*4
115 – 130 cm	*5
130 – 150 cm ^{1,2}	*6

Lumbamed® facet

Lumbar support for targeted relief of the facet joints

men: K.270.21*
women: K.270.21*

* = size; colour:  silver



Lumbamed® disc

Lumbar support with adjustable stabilisation system

men: K.220.33*
women: K.220.34*

* = size; colour:  silver



¹ size 6 only available for Lumbamed® facet and Lumbamed® disc.
² Lumbamed® disc circumference waist (men) size 6: 130 – 146 cm.

Product-overview

Foot / ankle supports

Achimed®

Comfort bandage for soft tissue
compression of the achilles tendon
with 3D silicone pad

Standard: K.020.21*

* = size; colour=  silver



Achimed®, Levamed® and
Levamed® active

circumference ankle (cm)	size
17 – 20	*1
20 – 22	*2
22 – 24	*3
24 – 26	*4
26 – 28	*5
28 – 30	*6

Levamed®

Comfort ankle support for soft tissue
compression with 3D silicon pads

Standard: K.010.21*

* = size; colour=  silver



Levamed® active

Comfort ankle support for soft tissue
compression with elastic strap

Standard: K.011.2◇*

◇ = orientation: 2 = left, 3 = right; * = size;
colour:  silver



Product-overview

Hand and elbow supports

Manumed active

Comfort wrist support for soft tissue compression with stabilizing rod

Standard: K.41◇.21*

◇ = orientation: 2 = left, 3 = right;
 colour: ■ silver; * = size



Manumed active

circumference wrist	size
13 – 15 cm	*1
15 – 17 cm	*2
17 – 19 cm	*3
19 – 21 cm	*4

Epicomed®

Comfort elbow support for soft tissue compression with 3D silicone pads

Standard: K.400.21*

* = size; colour= ■ silver

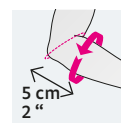

Epicomed®

circumference lower arm	size
17 – 20 cm	*1
20 – 23 cm	*2
23 – 26 cm	*3
26 – 29 cm	*4
29 – 32 cm	*5
32 – 35 cm	*6

Headquarters
medi GmbH & Co. KG
Medicusstraße 1
D-95448 Bayreuth
Germany
T +49 921 912-0
F +49 921 912-783
export@medi.de
www.medi.de/en



0097E46 / 06.2024